

UNIDAD 2

CORTE Y TRANSMISIÓN



CUCHILLAS DESMALEZADORAS	38
CUCHILLAS DE CORTACERCOS	41
PROTECTORES VARIOS	42
CAJAS DE ENGRANAJES	44
EJES CARDÁNICOS	45
BARRALES Y CAÑOS CURVOS	50
AMORTIGUADOR DE GOMA	51
MORDAZA DE AMORTIGUADOR	52









MANGOS Y MANILLAR DE AGARRE	53
MORDAZAS DE MANILLAR	55
PIÑONES Y ANILLOS	56
CAMPANAS	69
SOPORTE DE CAMPANA	71
TAPAS DE FRENO	72
MANIJAS DE FRENO	74

38

CUCHILLAS PARA DESMALEZADORA

CARLTON / HUSQVARNA

CUCHILLAS PARA DESMALEZADORA - CARLTON

Cod. Rumbo	Cod. Original	Marca	Centro	Puntas de corte	Diámetro	Aplicación
<input type="checkbox"/> 3169103	GRA3-255C	Carlton	1"	3 ptas	10"	Desmalezadoras
						
<input type="checkbox"/> 3169123	GRA3-300C	Carlton	1"	3 ptas	12"	Desmalezadoras
						
<input type="checkbox"/> 3169088	GRA8-200C	<u>Carlton</u>	1"	8 ptas	8"	Desmalezadoras
						
<input type="checkbox"/> 3169098	GRA8-225C	Carlton	1"	8 ptas	8 7/8"	Desmalezadoras
						
<input type="checkbox"/> 3170200	EIA-200-25C	Carlton	1"	22 ptas	8"	Desmalezadoras
						
<input type="checkbox"/> 3170250	EIA-225-20C	Carlton	3/4"	24 ptas	8 7/8"	Desmalezadoras
						
<input type="checkbox"/> 3171225	MAXI-225-25C	Carlton	1"	24 ptas	8 7/8"	Desmalezadoras
						
<input type="checkbox"/> 3170225	EIA-225-25C	Carlton	1"	24 ptas	8 7/8"	Desmalezadoras
						











Segui a **GRUPO RUMBO** en **Instagram** www.instagram.com/gruporumbo.arSegui a **NIWA** en **Instagram** www.instagram.com/niwa.arSegui a **HUSQVARNA** en **Instagram** www.instagram.com/husqvarna.ar

CUCHILLAS PARA DESMALEZADORA

CARLTON / HUSQVARNA

39

CUCHILLAS PARA DESMALEZADORA - HUSQVARNA



Cod. Rumbo	Cod. Original	Marca	Centro	Puntas de corte	Diámetro	Aplicación
<input type="checkbox"/> 8445101 	578 44 51-01	Husqvarna	1"	2ptas	13"	Husqvarna Multi
<input type="checkbox"/> 8444901 	578 44 49-01	Husqvarna	1"	3 Ptas	10"	Husqvarna Grass
<input type="checkbox"/> 8444501 	578 44 45-01	Husqvarna	1"	3ptas	12"	Husqvarna Multi
<input type="checkbox"/> 7149501 	537 14 95-01	Husqvarna	3/4"	4ptas	10"	Husqvarna Grass
<input type="checkbox"/> 8443701 	578 44 37-01	Husqvarna	1"	4ptas	10"	Husqvarna Grass
<input type="checkbox"/> 8444801 	578 44 48-01	Husqvarna	1"	4 Ptas	<u>10 3/4"</u>	Husqvarna Multi
<input type="checkbox"/> 7149201 	537 14 92-01	Husqvarna	1"	4ptas	10 3/4"	Husqvarna Multi
<input type="checkbox"/> 8444001 	578 44 40-01	Husqvarna	1"	8ptas	10"	Husqvarna Grass
<input type="checkbox"/> 8442501 	578 44 25-01	Husqvarna	1"	22ptas	8"	Husqvarna Scarlett
<input type="checkbox"/> 8442701 	578 44 27-01	Husqvarna	1"	24ptas	8 7/8"	Husqvarna Scarlett

40

CUCHILLAS PARA DESMALEZADORA

CARLTON / HUSQVARNA

CUCHILLAS PARA DESMALEZADORA - NIWA

Cod. Rumbo	Cod. Original	Marca	Centro	Puntas de corte	Diámetro	Aplicación
<input type="checkbox"/> 2260200	BG415-2	Niwa	1"	3 ptas	9"	Desmalezadora DNW26/33
						
<input type="checkbox"/> 2520420	CG420-2	Niwa	1"	3 ptas	10"	Desmalezadora DNW52
						

G.R.U.P.O
RUMBO

*¿Ya conocés la sección
de **CONTENIDOS** dentro de
la web de Grupo Rumbo*

*Haciendo click en **CONTENIDOS**,
podes acceder a catálogos, fichas técnicas,
spots publicitarios, puestas en marcha
y mucho más.*

Visite nuestra web:

www.rumbosrl.com.ar



CUCHILLAS PARA CORTACERCO





HUSQVARNA

41

CUCHILLAS PARA CORTACERCO - HUSQVARNA

Cod. Rumbo	Cod. Original	Marca	Largo	Alto	Ancho	Aplicación
□ 7122501	537 12 25-01	Husqvarna	23 1/4"	2 1/2"	1/8"	325HE4X
						
□ 5064801	505 06 48-01	Husqvarna	23 1/8"	2 1/2"	1/8"	327HE4x
						
□ 5065001	505 06 50-01	Husqvarna	27 1/2"	2 1/2"	1/8"	327HDA65x
						
□ 1590901	521 59 09-01	Husqvarna	27 5/8"	2 1/2"	1/8"	226HD60S
						
□ 6389001	586 38 90-01	Husqvarna	27 5/8"	2 1/2"	1/8"	226HD60S
						

CUCHILLAS PARA CORTACERCO - NIWA









Cod. Rumbo	Cod. Original	Marca	Largo	Alto	Ancho	Aplicación
□ 2708044	Niwa Original	Niwa	20 3/16"	2 1/2"	1/8"	KNW-33 DE ALTURA
						
□ 2232108	Niwa Original	Niwa	27 5/8"	3 1/8"	3/16"	HNW23 Superior a varilla M.viejo
						
□ 2232460	Niwa Original	Niwa	28 3/4"	2 1/2"	1/8"	Niwa HNW23 M. Nuevo (inferior o superior)
						
□ 2232138	Niwa Original	Niwa	30 3/4"	2 1/2"	1/8"	HNW23 inferior M.Viejo
						
□ 2232139	Niwa Original	Niwa	31 5/8"	2 1/2"	1/8"	HNW23 superior M.Viejo
						

42

PROTECTORES VARIOS

CARLTON / HUSQVARNA

PROTECTORES VARIOS - HUSQVARNA

Cod. Rumbo	Cod. Original	Tipo de protector	Aplicación
<input type="checkbox"/> 2138301	502 13 83-01	De cuchilla	Desmalezadora 132R
			
<input type="checkbox"/> 1007701	531 00 77-01	De cuchilla	Desmalezadora (M/Viejo) 142R
			
<input type="checkbox"/> 7331601	537 33 16-01	De cuchilla	Desmalezadora 143R
			
<input type="checkbox"/> 7331603	537 33 16-03	De cuchilla	Desmalezadora 143RII
			
<input type="checkbox"/> 3934202	503 93 42-02	De tanza	Desmalezadora 226r
			
<input type="checkbox"/> 2113902	502 11 39-02		Desmalezadora 240R/245R
			
<input type="checkbox"/> 7288501	537 28 85-01	De cuchilla	Desmalezadora 343R / 345RX/FR
			
<input type="checkbox"/> 3954301	503 95 43-01	De pasto	Desmalezadora 343R / 345RX/FR
			
<input type="checkbox"/> 7310902	537 31 09-02	De cuchilla	Desmalezadora 345FR
			



Lubricantes Husqvarna
La máxima protección para equipos 2T
Consulte con su asesor comercial

www.rumbosrl.com.ar

PROTECTORES VARIOS

NIWA / HUSQVARNA



43

2 | CORTE Y TRANSMISIÓN

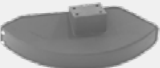
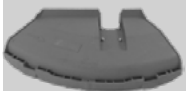

PROTECTORES VARIOS - NIWA

Cod. Rumbo	Cod. Original	Tipo de protector	Aplicación
<input type="checkbox"/> 2260500	Original Niwa	De tanza	Bordeadora BNW26/BNW25
			
<input type="checkbox"/> 2260131	Original Niwa	De cuchilla	Desmalezadora DNW26
			
<input type="checkbox"/> 2260711	Original Niwa	De cuchilla	Desmalezadora DNW52/DNW33
			

PROTECTORES DE AGARRE - NIWA

Cod. Rumbo	Cod. Original	Tipo de protector	Aplicación
<input type="checkbox"/> 2226045	Original Niwa	De agarre superior	Sopladora SNW26 (Izquierdo)
			
<input type="checkbox"/> 2226041	Original Niwa	De agarre superior	Sopladora SNW26 (Derecho)
			

PROTECTORES DE MAQUINAS DE CONSTRUCCIÓN - HUSQVARNA









Cod. Rumbo	Cod. Original	Tipo de protector	Aplicación
<input type="checkbox"/> 6271704	506 27 17-04	De correa	Cortadora de potencia K1260
			
<input type="checkbox"/> 6340542	506 34 05-42	De disco	Cortadora de potencia K 760
			

44

CAJAS DE ENGRANAJES

HUSQVARNA

CAJAS DE ENGRANAJES COMPLETAS - HUSQVARNA

Cod. Rumbo	Cod. Original	Centro	Aplicación
<input type="checkbox"/> 0096295	530 09 62-95	Cuadrado	Desmalezadora Husqvarna 125R/128R
			
<input type="checkbox"/> 8818301	528 81 83-01	Cuadrado	Desmalezadora Husqvarna 143R/II/236R
			
<input type="checkbox"/> 1007892	531 00 78-92	Cuadrado	Desmalezadora Husqvarna 132R
			
<input type="checkbox"/> 7333202	537 33 32-02	Cuadrado	Desmalezadora Husqvarna 133R/226R
			
<input type="checkbox"/> 7295804	537 29 58-04	Cuadrado	Desmalezadora Husqvarna 143R
			
<input type="checkbox"/> 2219208	502 21 92-08	Cuadrado	Desmalezadora Husqvarna 225R/232R
			
<input type="checkbox"/> 9076201	579 07 62-01	Cuadrado	Desmalezadora Husqvarna 236R 543RS
			
<input type="checkbox"/> 4216401	544 21 64-01	Cuadrado	Desmalezadora Husqvarna 241R
			
<input type="checkbox"/> 2235201	502 23 52-01	10 Estrias	Desmalezadora Husqvarna 343R/345FR/545FR
			
<input type="checkbox"/> 8831001	528 83 10-01	11 Estrias	Desmalezadora Husqvarna 553RS
			
<input type="checkbox"/> 1007770	531 00 77-70	Cuadrado	Desmalezadora Husqvarna 142R
			

CAJAS DE ENGRANAJES

HUSQVARNA

45







CAJAS DE ENGRANAJES COMPLETAS - HUSQVARNA

Cod. Rumbo	Cod. Original	Centro	Aplicación
<input type="checkbox"/> 3702401	593 70 24-01	Cuadrado	Desmalezadora Husqvarna 131R/Husqvarna 331R
			

EJES CARDÁNICOS

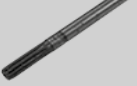
HUSQVARNA

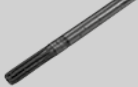
EJES CARDÁNICOS - HUSQVARNA













Cod. Rumbo	Cod. Original	Largo	Diámetro	Punta lado caja de engranaje	Punta lado campana	Aplicación
<input type="checkbox"/> 7411702	587 41 17-02	111,5cm	0,7cm	Rosca Hembra	7 estrias	325P5/327P5x Superior
						
<input type="checkbox"/> 7014005	537 01 40-05	136,5cm	1cm	4 estrias	Rosca M10x1,5	Desmalezadora Husqvarna 165RX/265RX
						
<input type="checkbox"/> 3924403	503 92 44-03	143cm	0,9cm	10 estrias	Rosca M9x1,25	Desmalezadora Husqvarna 343FR/345FR
						
<input type="checkbox"/> 1582201	511 58 22-01	147cm	1cm	11 estrias	11 estrias	Desmalezadora Husqvarna 553RS
						
<input type="checkbox"/> 8229829	538 22 98-29	149,3cm	0,8cm	10 estrias	10 estrias	Mc ELITE 4100 PRO/4700
						
<input type="checkbox"/> 4183201	544 18 32-01	152,5cm	0,8cm	Cuadrada	<u>Cuadrada</u>	Desmalezadora 241R
						
<input type="checkbox"/> 7234801	537 23 48-01	152cm	0,7cm	Cuadrada	7 estrias	Cortacercos de Altura Husqvarna 327HE4x
						

46

EJES CARDÁNICOS

HUSQVARNA

EJES CARDÁNICOS - HUSQVARNA

Cod. Rumbo	Cod. Original	Largo	Diámetro	Punta lado caja de engranaje	Punta lado campana	Aplicación
<input type="checkbox"/> 2191002	502 19 10-02	153 cm	0,7cm	Cuadrada	Rosca M8x1,25	Husqvarna 132R
						
<input type="checkbox"/> 8228109	538 22 81-09	153cm	0,9cm	Cuadrada	Cuadrada	ELITE 3100
						
<input type="checkbox"/> 3943201	583 94 32-01	154,5cm	0,8cm	Cuadrada	9 estrias	Desmalezadora Husqvarna 143RII
						
<input type="checkbox"/> 8841901	528 84 19-01	154cm	0,7cm	Cuadrada	7 estrias	Desmalezadora Husqvarna 226R/533RS
						
<input type="checkbox"/> 7014004	537 01 40-04	154cm	1cm	4 estrias	Rosca M10x1,5	Husqvarna 250R
						
<input type="checkbox"/> 4149601	544 14 96-01	156,5cm	0,8cm	Cuadrada	Rosca M8x1,25	Desmalezadora Husqvarna 143R
						
<input type="checkbox"/> 1007727	531 00 77-27	157cm	0,9cm	Cuadrada	Rosca M8x1,25	Desmalezadora Husqvarna 142R
						
<input type="checkbox"/> 7181001	537 18 10-01	169,9cm	0,7cm	7 estrias	Rosca M7x1,0	Husqvarna 325P5 L=1699 INFERIOR
						
<input type="checkbox"/> 7234806	537 23 48-06	169,9cm	0,7cm	7 estrias	Rosca M7x1,0	Husqvarna 327P5x L=1699 INFERIOR
						
<input type="checkbox"/> 7234803	537 23 48-03	179cm	0,7cm	Cuadrada	7 estrias	Husqvarna 327P5
						
<input type="checkbox"/> 6925601	576 92 56-01	207,5cm	1,2cm	7 estrias	7 estrias	327PT5S y Protector
						
<input type="checkbox"/> 6925602	576 92 56-02	207,5cm	1,2cm	7 estrias	7 estrias	Podador de altura Husqvarna 525PT5S
						

EJES CARDÁNICOS

HUSQVARNA

47

EJES CARDÁNICOS - NIWA

Cod. Rumbo	Cod. Original	Largo	Diámetro	Punta lado caja de engranaje	Punta lado campana	Aplicación
<input type="checkbox"/> 2260410	Niwa Original	137,3cm	0,8cm	9 estrias	9 estrias	Desmalezadora Niwa DNW-26
<input type="checkbox"/> 2520333	Niwa Original	152cm	0,8cm	9 estrias	9 estrias	Desmalezadora Niwa DNW-33/52
<input type="checkbox"/> 2133211	Niwa Original	236,5cm	1,1cm	7 estrias	7 estrias	Podador de altura Niwa JNW-27

EJES CARDÁNICOS - STHIL

Cod. Rumbo	Cod. Original	Largo	Diámetro	Punta lado caja de engranaje	Punta lado campana	Aplicación
<input type="checkbox"/> 3991220	4119.711.3201	161cm	0,8cm	Cuadrada	Cuadrada	Desmalezadora Stihl FS-160/220/ 280

EJES FLEXIBLES

Cod. Rumbo	Cod. Original	Largo	Diámetro	Punta lado caja de engranaje	Punta lado campana	Aplicación
<input type="checkbox"/> 2123001	Niwa Original	129cm	0,6cm	Cuadrada	Cuadrada	Bordeadora Niwa BNW-23
<input type="checkbox"/> 2132185	Niwa Original	135cm	0,6cm	Cuadrada	Cuadrada	Bordeadora Niwa BNW-25
<input type="checkbox"/> 2260261	Niwa Original	148,5cm	0,6cm	Cuadrada	Cuadrada	Bordeadora Niwa BNW-26

48

BARRALES HUSQVARNA

BARRALES - HUSQVARNA

Cod. Rumbo	Cod. Original	Largo	Diámetro interior	Diámetro exterior	Aplicación
<input type="checkbox"/> 0915601	570 91 56-01	148,3 cm	2,1cm	2,5cm	Desmalezadora Husqvarna 143RII/236R Desde 2009
<input type="checkbox"/> 1007822	531 00 78-22	150cm	2,2cm	2,8cm	Desmalezadora Husqvarna 142R
<input type="checkbox"/> 1660801	521 66 08-01	150cm	2,4cm	2,8cm	Desmalezadora Husqvarna 553RS
<input type="checkbox"/> 2252501	502 25 25-02	110cm	2,1cm	2,4cm	Husqvarna 165RX/265RX
<input type="checkbox"/> 3889401	503 88 94-01	148cm	2,1cm	2,8cm	Desmalezadora Husqvarna 235R
<input type="checkbox"/> 4149701	544 14 97-01	145cm	2,5cm	<u>2,8cm</u>	Desmalezadora Husqvarna 143R
<input type="checkbox"/> 5294301	505 29 43-01	150cm	2,4cm	2,8cm	Desmalezadora Husqvarna 143RII Hasta 2008
<input type="checkbox"/> 6262604	586 26 26-04	138,5cm	2,6cm	3,2cm	Desmalezadora Husqvarna 345FR
<input type="checkbox"/> 7174801	537 17 48-01	110cm	2,1cm	2,4cm	Husqvarna 325P5/327P5x L=1100
<input type="checkbox"/> 7175001	537 17 50-01	165cm	3,5cm	3,8cm	Husqvarna 325P5/327P5x L=1650
<input type="checkbox"/> 8842001	528 84 20-01	150cm	2,1cm	2,4cm	Husqvarna 226R
<input type="checkbox"/> 0097002	510 09 70-02	335cm	1,8cm	2,8cm/3,8cm/2,4cm (3 tramos)	Podador de altura Husqvarna 327PT5S/525PT5S

BARRALES
HUSQVARNA

49

BARRALES - HUSQVARNA

Cod. Rumbo	Cod. Original	Largo	Diámetro interior	Diámetro exterior	Aplicación
<input type="checkbox"/> 5006068	545 00 60-68	144cm	2,2cm	2,6cm	Desmalezadora Husqvarna 128R
					
<input type="checkbox"/> 5081011	545 08 10-11	144cm	2,2cm	2,6cm	Desmalezadora Husqvarna 125R
					
<input type="checkbox"/> 6925501	576 92 55-01	165cm	3,5cm	3,8cm	Podador de altura Husqvarna 327PT5S
					
<input type="checkbox"/> 6925801	576 92 58-01	152,5cm	1,8cm/2,0cm	2,8cm	Podador de altura Husqvarna 327PT5S
					

BARRALES - NIWA

Cod. Rumbo	Cod. Original	Largo	Diámetro interior	Diámetro exterior	Aplicación
<input type="checkbox"/> 2330110	Niwa Original	150cm	2,2cm	2,6cm	Desmalezadora Niwa DNW33/52/PAMPA PRO DPP-52
					
<input type="checkbox"/> 2260021	Niwa Original	137cm	2,2cm	2,6cm	Desmalezadora Niwa DNW26
					

SUSCRIBITE A NUESTRO CANAL DE YOUTUBE



www.youtube.com/user/rumbosrl



50

BARRALES Y CAÑOS CURVOS

HUSQVARNA

CAÑO CURVO - HUSQVARNA

Cod. Rumbo	Cod. Original	Largo	Diámetro interior	Diámetro exterior	Aplicación
□ 7088401	537 08 84-01	133cm	2,0cm	2,3cm	Bordeadora Husqvarna 322C
					
□ 5755601	575 75 56-01	136cm	2,3cm	2,6cm	Bordeadora Husqvarna 128C
					

CAÑO CURVO - NIWA

Cod. Rumbo	Cod. Original	Largo	Diámetro interior	Diámetro exterior	Aplicación
□ 2123003	Niwa Original	135cm	1,9cm	2,2cm	Bordeadora Niwa BNW-23
					
□ 2132171	Niwa Original	136cm	2,3cm	2,6cm	Bordeadora Niwa BNW-25
					
□ 2260263	Niwa Original	153,5cm	1,9cm	2,2cm	Bordeadora Niwa BNW26
					



AMORTIGUADORES

HUSQVARNA

51

AMORTIGUADOR - HUSQVARNA

Cod. Rumbo	Cod. Original	Largo	Diámetro interior	Diámetro exterior	Aplicación
<input type="checkbox"/> 5293301	505 29 33-01	21mm	38mm	61mm	Desmalezadora Husqvarna 143R/143RII/236R (chico barral)
<input type="checkbox"/> 5293401	505 29 34-01	21mm	45mm	73mm	Desmalezadora Husqvarna 143R/143RII/236R (grande barral)
<input type="checkbox"/> 2360501	512 36 05-01	48mm	21mm	34mm	Desmalezadora Husqvarna 226r(barral)
<input type="checkbox"/> 1665101	521 66 51-01	20mm	26mm	45mm	Desmalezadora Husqvarna 553RS (tubo lado embrague)
<input type="checkbox"/> 6420501	576 42 05-01	47mm	28mm	44mm	Husqvarna 525PT5S(barral)

AMORTIGUADOR - NIWA

Cod. Rumbo	Cod. Original	Largo	Diámetro interior	Diámetro exterior	Aplicación
<input type="checkbox"/> 2260956	Niwa Original	58mm	13mm	42mm	Bordeadora Niwa BNW26
<input type="checkbox"/> 2260142	Niwa Original	58mm	23mm	42mm	Desmalezadora Niwa DNW26/33/52/JNW27

VISITÁ EL BLOG DE GRUPO RUMBO
y encontrará tips y recomendaciones



www.rumbosrl.com.ar/blog









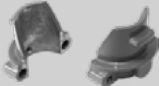

52

MORDAZA Y SOPORTE DE AMORTIGUADOR Y BARRAL

NIWA / HUSQVARNA

MORDAZA Y SOPORTE DE AMORTIGUADOR Y BARRAL



Cod. Rumbo	Cod. Original	Aplicación
<input type="checkbox"/> 2520752 	NIWA ORIGINAL	Desmalezadora Niwa DNW26/33/52/JNW27
<input type="checkbox"/> 2520751 	NIWA ORIGINAL	Desmalezadora NiwaDNW26/33/52/JNW27
<input type="checkbox"/> 2260955 	NIWA ORIGINAL	Bordeadora Niwa BNW26
<input type="checkbox"/> 5293201 	505 29 32-01	Desmalezadora Husqvarna 143R/143RII/236R
<input type="checkbox"/> 4721201 	574 72 12-01	Desmalezadora Husqvarna 143RII / 236R/143AE15
<input type="checkbox"/> 4110203 	544 11 02-01	Desmalezadora Husqvarna 241R
<input type="checkbox"/> 7041207 	537 04 12-07	Husqvarna 323P4 / 325P5
<input type="checkbox"/> 3954104 	503 95 41-04	Desmalezadora Husqvarna 343/345FR
<input type="checkbox"/> 7198905 	537 19 89-05	Husqvarna 343R/345RX
<input type="checkbox"/> 1768301 	521 76 83-01	Desmalezadora Husqvarna 226R
<input type="checkbox"/> 1768201 	521 76 82-01	Desmalezadora Husqvarna 226R

MANGOS Y MANILLAR DE AGARRE





HUSQVARNA / NIWA

53

MANGOS DE AGARRE - NIWA

Cod. Rumbo	Cod. Original	Aplicación
<input type="checkbox"/> 2520112	NIWA ORIGINAL	Desmalezadora Niwa DNW26/33/52
		
<input type="checkbox"/> 2260120	NIWA ORIGINAL	Bordeadora Niwa BNW26
		
<input type="checkbox"/> 2137075	NIWA ORIGINAL	Motosierra Niwa CNW36
		
<input type="checkbox"/> 2162129	NIWA ORIGINAL	Motosierra Niwa CNW62
		
<input type="checkbox"/> 2520111	NIWA ORIGINAL	Desmalezadora Niwa DNW26/33/52
		

MANILLAR DE AGARRE - HUSQVARNA

Cod. Rumbo	Cod. Original	Aplicación
<input type="checkbox"/> 8817401	528 81 74-01	Desmalezadora 226R/236R/553RS/143RII (derecho)
		
<input type="checkbox"/> 1007828	531 00 78-28	Desmalezadora 142R/143R (derecho)
		
<input type="checkbox"/> 8817801	528 81 78-01	Desmalezadora 236R/143RII (derecho)
		
<input type="checkbox"/> 8817501	528 81 75-01	Desmalezadora 226R/236R/143RII/553RS (izquierda)
		

54

MANGOS Y MANILLAR DE AGARRE

HUSQVARNA

MANILLAR DE AGARRE - HUSQVARNA

Cod. Rumbo	Cod. Original	Aplicación
□ 5312901	505 31 29-01	Desmalezadora 236R/143RII (izquierda)
□ 3706201	593 70 62-01	desmalezadora 131R /331R

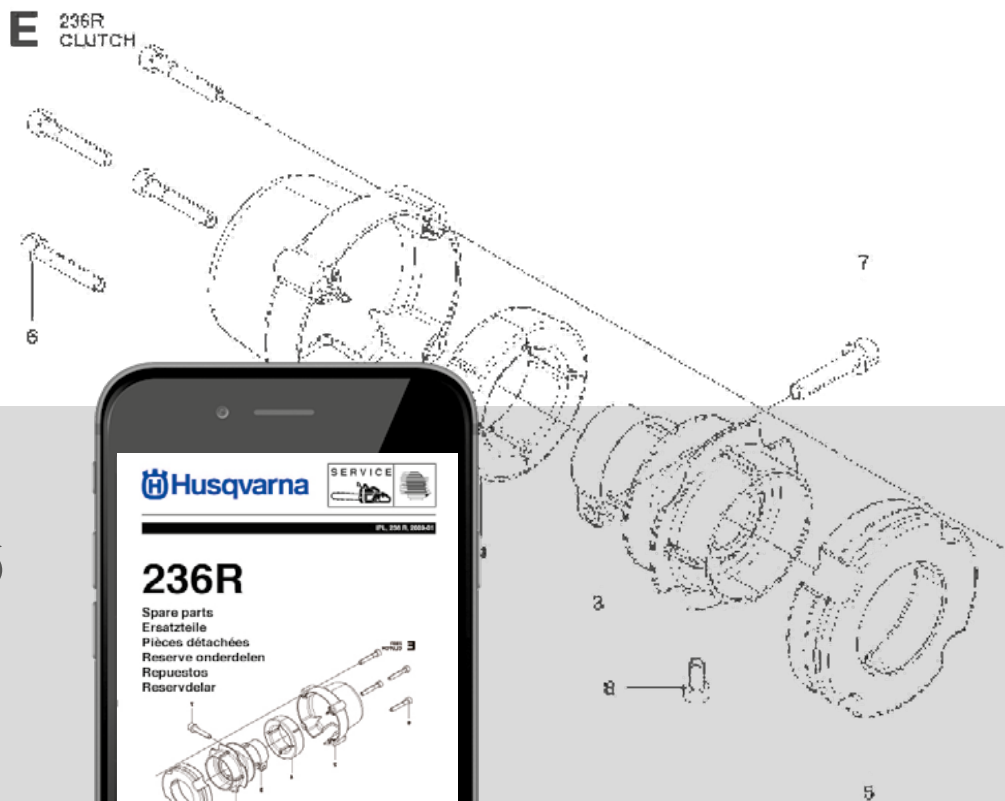

Grupo Rumbo te la hace fácil
Encontrá desde nuestra web
los despieces,
de todos nuestros equipos.









www.rumbosrl.com.ar

MORDAZA DE MANILLAR

HUSQVARNA / NIWA

55

MORDAZA DE MANILLAR

Cod. Rumbo	Cod. Original	Aplicación
<input type="checkbox"/> 5294601	505 29 46-01	Desmalezadora Husqvarna 143RII / 236R
		
<input type="checkbox"/> 1822101	521 82 21-01	Desmalezadora Husqvarna 226r
		
<input type="checkbox"/> 4225802	544 22 58-02	Desmalezadora Husqvarna 241R
		
<input type="checkbox"/> 7983001	577 98 30-01	Desmalezadora Husqvarna 553RS
		
<input type="checkbox"/> 6283301	596 28 33-01	343R/345RX/545FR(INFERIOR)
		
<input type="checkbox"/> 3825401	593 82 54-01	Desmalezadora 131R
		
<input type="checkbox"/> 2000152	NIWA ORIGINAL	Desmalezadora Niwa DNW26/33/52
		
<input type="checkbox"/> 2000151	NIWA ORIGINAL	Desmalezadora Niwa DNW26/33/52
		
<input type="checkbox"/> 2000153	NIWA ORIGINAL	Desmalezadora Niwa DNW26/33/52
		

56

PIÑONES
HUSQVARNA











PIÑONES PARA MOTOSIERRA - HUSQVARNA

Cod. Rumbo	Cod. Original	Tipo	Dientes	Paso	Diámetro	Centro	Alto total Tambor / Piñón	Aplicación
□ 3212161		Estrella	6	3/8"LP	62mm	13mm	23mm	Motosierra Husqvarna 33/34/35/38
□ 0047061	530 04 70-61	Estrella	6	3/8"LP	63,5mm	13mm	23mm	Motosierra Husqvarna 236e
□ 3230372	503 15 98-01	CTA	7	.325"	67mm	16mm	27mm	Motosierra Husqvarna 40/41
□ 3980002	503 98 00-02	CTA	7	.325"	69mm	16mm	29,2mm	Motosierra Husqvarna 346X
□ 3745401	503 74 54-01	CTA	7	.325"	73mm	16mm	27mm	Motosierra Husqvarna 55
□ 3646603	503 64 66-03	CTA	7	.325"	73mm	16mm	27mm	Motosierra Husqvarna 257
□ 3453902	503 45 39-02	CTA	7	.325"	73mm	16mm	27mm	Motosierra Husqvarna 55
□ 3230371	503 74 54-01	CTA	7	.325"	73mm	16mm	27mm	Motosierra Husqvarna 150/151/262/50/51
□ 3252175	6-29175X	CTA	7	.325"	73mm	16mm	27mm	Motosierra Husqvarna 50,55,262, MS260
□ 0069316	530 06 93-16	CTA	7	.325"	66,5mm	13mm	27mm	Motosierra Husqvarna 136
□ 3230373	503 98 00-02	CTA	7	.325"	66,5mm	13mm	27mm	Motosierra Husqvarna 36/41/136/141

PIÑONES
HUSQVARNA

57

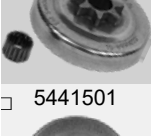
PIÑONES PARA MOTOSIERRA - HUSQVARNA

Cod. Rumbo	Cod. Original	Tipo	Dientes	Paso	Diámetro	Centro	Alto total Tambor / Piñón	Aplicación
 3159801	503 15 98-01	CTA	7	.325"	67mm	16mm	27mm	Motosierra Husqvarna 45
 3230374	505 44 15-01	CTA	7	.325"	72,5mm	16mm	26mm	Motosierra Husqvarna 350/351/345
 3252215	6-108215X	CTA	7	.325"	72,5mm	16mm	26mm	Motosierra Husqvarna 345,357,351,346
 7291702	537 29 17-02	Estrella	7	.325"	69,3mm	16mm	29,4mm	Motosierra Husqvarna 455e
 3212375	530 04 81-32	Estrella	7	.325"	63,5mm	13mm	23mm	Motosierra Husqvarna 37/137
 0048132	530 04 81-32	Estrella	7	.325"	63,5mm	13mm	23mm	Motosierra Husqvarna 137/236e
 3212371	503 15 98-01	Estrella	7	.325"	67mm	16mm	27mm	Motosierra Husqvarna 45/40
 8097901	578 09 79-01	Estrella	7	.325"	72,5mm	16mm	26mm	Motosierra Husqvarna 445e/340/345
 3212376	578 09 79-01	Estrella	7	.325"	72,5mm	16mm	26mm	Motosierra Husqvarna 350/351/345
 3212373	503 08 87-02	Estrella	7	.325"	73mm	16mm	27mm	Motosierra Husqvarna 51/50
 5441501	505 44 15-01	Estrella	7	.325"	69mm	16mm	13,5mm	Motosierra Husqvarna 435e

58











PIÑONES HUSQVARNA

PIÑONES PARA MOTOSIERRA - HUSQVARNA

Cod. Rumbo	Cod. Original	Tipo	Dientes	Paso	Diámetro	Centro	Alto total Tambor / Piñón	Aplicación
<input type="checkbox"/> 0069342	530 06 93-42	Estrella	7	.325"	66,5mm	13mm	27mm	Motosierra Husqvarna 136
<input type="checkbox"/> 3218372	530 06 93-42	Estrella	7	.325"	66,5mm	13mm	27mm	Motosierra Husqvarna 36/41/136/141
<input type="checkbox"/> 3251656	5-106656X	Estrella	7	.325"	66,5mm	13mm	27mm	Motosierra Husqvarna 36/136 Poulan 295
<input type="checkbox"/> 4124301	574 12 43-01	Estrella	7	.325"	69,3mm	16mm	29,4mm	Motosierra Husqvarna 455
<input type="checkbox"/> 3251308	5-108308X	Estrella	7	.325"	72,5mm	16mm	26mm	Motosierra Husqvarna 345/350/340/450/2141/445e
<input type="checkbox"/> 3088702	503 08 87-02	Estrella	7	.325"	73mm	16mm	27mm	Motosierra Husqvarna 50/51/55
<input type="checkbox"/> 6980601	586 98 06-01	CTA	7	3/8"	82mm	16mm	28mm	Motosierra Husqvarna 365/372XP
<input type="checkbox"/> 1831504	501 83 15-04	CTA	7	3/8"	82mm	17mm	31mm	Motosierra Husqvarna 61
<input type="checkbox"/> 3230271	501 83 15-04	CTA	7	3/8"	82mm	17mm	31mm	Motosierra Husqvarna 61/66/162/266/268/272
<input type="checkbox"/> 3625903	503 62 59-03	CTA	7	3/8"	82mm	17mm	36mm	Motosierra Husqvarna 288XP
<input type="checkbox"/> 3230272	586 98 06-01	CTA	7	3/8"	82mm	16mm	28mm	Motosierra Husqvarna 371/365/372/362

PIÑONES
HUSQVARNA

PIÑONES PARA MOTOSIERRA - HUSQVARNA











Cod. Rumbo	Cod. Original	Tipo	Dientes	Paso	Diámetro	Centro	Alto total Tambor / Piñón	Aplicación
<input type="checkbox"/> 3252772	6-105772X	CTA	7	3/8"	82mm	16mm	28mm	Motosierra Husqvarna 365, 371
								
<input type="checkbox"/> 3252469	6-102469	CTA	7	3/8"	82mm	17mm	31mm	Motosierra Husqvarna 61,66,268,272
								
<input type="checkbox"/> 3252094	6-28094X	CTA	7	3/8"	82mm	17mm	36mm	Motosierra Husq. 395, 288, 281
								
<input type="checkbox"/> 3082601	<u>523 08 26-01</u>	Estrella	7	3/8"	63mm	13mm	27mm	Motosierra Husqvarna T435
								
<input type="checkbox"/> 4718501	574 71 85-01	Estrella	7	3/8"	72mm	13mm	26mm	Motosierra Husqvarna 120/125
								
<input type="checkbox"/> 3218272	503 93 24-72	Estrella	7	3/8"	82mm	16mm	28mm	Motosierra Husqv 365/371/362/372
								
<input type="checkbox"/> 3212271	501 51 40-01	Estrella	7	3/8"	82mm	17mm	31mm	Motosierra Husqvarna 61/266/268/272
								
<input type="checkbox"/> 3251057	5-32057	Estrella	7	3/8"	82mm	17mm	31mm	Motosierra Husqvarna 61/266/268/272
								
<input type="checkbox"/> 3932472	503 93 24-72	Estrella	7	3/8"	82mm	16mm	28mm	Motosierra Husqvarna 365/372
								
<input type="checkbox"/> 7291604	537 29 16-04	Estrella	7	3/8"	63,5mm	16mm	16mm	Motosierra Husqvarna 455e
								

2 | CORTE Y TRANSMISIÓN

60

PIÑONES
HUSQVARNA

ES PARA MOTOSIERRA - STIHL

Cod. Rumbo	Cod. Original	Tipo	Dientes	Paso	Diámetro	Centro	Alto total Tambor / Piñón	Aplicación
 3252961	6-100961X	Carlton CTA	6	3/8"LP	69mm	13mm	28mm	Motosierra Stihl 017,018,021,025
 3211262	1123 640 2003	Estrella	6	3/8"LP	69mm	13mm	28mm	Motosierra Stihl 017/018/021/025
 3211261	1120 640 2005	Estrella	6	3/8"LP	69mm	13mm	28mm	Motosierra Stihl 09/011
 3251962	5-100962X	Estrella	6	3/8"LP	69mm	13mm	28mm	Motosierra Stihl 017/019/021/210/023
 3230376	1123 640 2074	CTA	7	.325"	65,8mm	13mm	28mm	Motosierra Stihl MS250
 3211373	1124 640 2000	Estrella	7	.325"	65,8mm	13mm	<u>28mm</u>	Motosierra Stihl 021/023/025
 3211374	1121 640 2004	Estrella	7	.325"	72mm	10mm	18mm	Motosierra Stihl 026/ 260
 3252162	6-34162X	Carlton CTA	7	3/8"	79mm	13mm	30mm	Motosierra Stihl MS290,360,390,361
 3252460	1128 007 1000	Carlton CTA	7	3/8"	80mm	10mm	35mm	Motosierra Stihl MS361
 3252791	6-100791X	Carlton CTA	7	3/8"	71mm	13mm	28mm	Motosierra Stihl MS270C
 3230273	1119 640 2000	CTA	7	3/8"	75mm	15mm	42mm	Motosierra Stihl 038/380

PIÑONES

STIHL

61

ES PARA MOTOSIERRA - STIHL

Cod. Rumbo	Cod. Original	Tipo	Dientes	Paso	Diámetro	Centro	Alto total Tambor / Piñón	Aplicación
<input type="checkbox"/> 3211278	1128 007 1000	CTA	7	3/8"	80mm	10mm	35mm	Motosierra Stihl 044/046/MS440/MS460
								
<input type="checkbox"/> 3230275	1128 007 1000	CTA	7	3/8"	80mm	10mm	35mm	Motosierra Stihl MS360 / MS361
								
<input type="checkbox"/> 3230375	1123 640 2073	CTA	7	3/8"	69mm	13mm	28mm	Motosierra Stihl 017/021/025
								
<input type="checkbox"/> 3211271	<u>1119 640 2000</u>	Estrella	7	3/8"	75mm	15mm	42mm	Motosierra Stihl 038 / 380
								
<input type="checkbox"/> 3230274	1125 640 2004	Estrella	7	3/8"	76mm	10mm	20,5mm	Motosierra Stihl 029/290/034/340/036/360 039
								
<input type="checkbox"/> 3211263	1125 007 1041	Estrella	7	3/8"	76mm	10mm	20,5mm	Motosierra Stihl 034/029/039/026
								
<input type="checkbox"/> 3211274	1115-640-2005	Estrella	7	3/8"	77,5mm	17mm	37mm	Motosierra Stihl 045/056
								
<input type="checkbox"/> 3211275	1128 007 1000	Estrella	7	3/8"	80mm	10mm	35mm	Motosierra Stihl MS360 / MS361
								
<input type="checkbox"/> 3211277	1122 160 2900	Estrella	7	3/8"	81,2mm	16mm	34,9mm	Motosierra Stihl 064/066/MS640/660
								
<input type="checkbox"/> 3252818	6-108818X	Carlton CTA	7	.404"	84mm	18mm	45mm	Motosierra Stihl 070
								
<input type="checkbox"/> 3230280	1108 640 2025	CTA	7	.404"	67mm	18mm	21,3mm	Motosierra Stihl 08/08S
								

62











PIÑONES

STIHL / OLEOMAC

ES PARA MOTOSIERRA - STIHL

Cod. Rumbo	Cod. Original	Tipo	Dientes	Paso	Diámetro	Centro	Alto total Tambor / Piñón	Aplicación
<input type="checkbox"/> 3211474	1106 640 2011	Estrella	7	.404"	77,8mm	18mm	44,65mm	Motosierra Sthil 070
								
<input type="checkbox"/> 3211472	1108 640 2000	Estrella	7	404"	67mm	18mm	21,3mm	Motosierra Stihl 08
								
<input type="checkbox"/> 3211473	0028 913 2072	Estrella	7	404"	86mm	18mm	35,3mm	Motosierra Stihl 051/076
								

PIÑONES PARA MOTOSIERRA - OLEOMAC

Cod. Rumbo	Cod. Original	Tipo	Dientes	Paso	Diámetro	Centro	Alto total Tambor / Piñón	Aplicación
<input type="checkbox"/> 3216262	360039	Estrella	6	3/8"LP	58,3mm	10,9mm	26,5mm	<u>Motosierra OleoMac 935</u>
								
<input type="checkbox"/> 3216261	360040	Estrella	6	3/8"LP	58,6mm	14mm	38,4mm	Motosierra Oleomac 233/240/244/335
								
<input type="checkbox"/> 3216161	360056	Estrella	6	3/8"LP	68,2mm	13mm	30,4mm	Motosierra Oleamac 931
								
<input type="checkbox"/> 3216162	120288	Estrella	6	3/8"LP	68,2mm	13mm	30,4mm	Motosierra Oleomac 936/942
								
<input type="checkbox"/> 3216271	5000918	Estrella	7	3/8"LP	68,2mm	14mm	29,4mm	Motosierra Oleomac 250/251/330/355
								
<input type="checkbox"/> 3216371	360045	Estrella	7	.325"	63,4mm	15mm	29mm	Motosierra Oleomac 938/941/2/4/56/50
								
<input type="checkbox"/> 3216281	120029	Estrella	8	3/8"	79mm	19mm	29,3mm	Motosierra Oleomac 261/271/272/280
								

PIÑONES

ECHO

PIÑONES PARA MOTOSIERRA - ECHO

Cod. Rumbo	Cod. Original	Tipo	Dientes	Paso	Diámetro	Centro	Alto total Tambor / Piñón	Aplicación
<input type="checkbox"/> 3213162	175005-3913-1	Estrella	6	3/8" LP	60mm	13mm	26,5mm	<u>Motosierra Echo 3000/3400/3450/3500</u>
<input type="checkbox"/> 3213161	A556-00097-0	Estrella	6	3/8"LP	70mm	13mm	24,2mm	Motosierra Echo CS 302/315/351/360
<input type="checkbox"/> 3213371	A556-00017-1	Estrella	7	.325"	70mm	14mm	23,8mm	Motosierra Echo CS360/3900/4100/4200
<input type="checkbox"/> 3213372	175105-1983-1	Estrella	7	.325"	69,8mm	15mm	25,6mm	Motosierra Echo 4000/4010/4600/5000
<input type="checkbox"/> 3213275	175105-3543-0	Estrella	7	3/8"	70mm	14mm	23,8mm	Motosierra Echo CS400/4200/4400/4500
<input type="checkbox"/> 3213272	177206-1233-1	Estrella	7	3/8"	77,5mm	14mm	<u>26,6mm</u>	Motosierra Echo CS451/452/500/440/610
<input type="checkbox"/> 3213274	552-8202-0	Estrella	7	3/8"	77,7mm	14mm	29,7mm	Motosierra Echo CS602/VL702/750
<input type="checkbox"/> 3213273	175005-1433-0	Estrella	7	3/8"	77,7mm	18mm	27,5mm	Motosierra Echo CS6700/CS6701

VISITANOS EN LINKEDIN Y CONECTÁ CON GRUPO RUMBO



www.linkedin.com/company/gruporumbo



64

PIÑONES

MC CULLOCK / HOMELITE / SOLO



PIÑONES PARA MOTOSIERRA - MC CULLOCK

Cod. Rumbo	Cod. Original	Tipo	Dientes	Paso	Diámetro	Centro	Alto total Tambor / Piñón	Aplicación
<input type="checkbox"/> 3215161	656053	Estrella	6	3/8" Lp	73mm	10mm	26mm	<u>Motosierra Mc Culloch 110/140/2000/2016</u>
								
<input type="checkbox"/> 3251888	5-29888	Estrella	7	3/8"	72,5mm	13mm	26mm	Motosierra McCulloch 365/201 y otros
								

PIÑONES PARA MOTOSIERRA - HOMELITE

Cod. Rumbo	Cod. Original	Tipo	Dientes	Paso	Diámetro	Centro	Alto total Tambor / Piñón	Aplicación
<input type="checkbox"/> 3214162	A95653B	Estrella	6	3/8" LP	61,8mm	14,1mm	29,2mm	<u>Motosierra Homelite 190/5240</u>
								
<input type="checkbox"/> 3214371	A 06867	Estrella	7	.325"	65mm	14mm	29mm	Motosierra Homelite 4150/455
								
<input type="checkbox"/> 3214161	007589	Estrella	6	3/8"	62mm	14mm	26,8mm	Motosierra Homelite 3300/3350/3850/3800
								

PIÑONES PARA MOTOSIERRA - SOLO







Cod. Rumbo	Cod. Original	Tipo	Dientes	Paso	Diámetro	Centro	Alto total Tambor / Piñón	Aplicación
<input type="checkbox"/> 3219161	010537	Estrella	6	3/8" LP	68mm	13mm	29mm	<u>Motosierra Solo 635/ 636</u>
								
<input type="checkbox"/> 3219373		Estrella	7	.325"	69,7mm	13mm	30,4mm	Motosierra Solo 644/651/639/645/650
								
<input type="checkbox"/> 3219271	3500359	Estrella	7	3/8"	70mm	13mm	31mm	Motosierra Solo 662/667
								

PIÑONES

ALPINA / POULAN

65

PIÑONES PARA MOTOSIERRAS - ALPINA / POULAN

Cod. Rumbo	Cod. Original	Tipo	Dientes	Paso	Diámetro	Centro	Alto total Tambor / Piñón	Aplicación
<input type="checkbox"/> 3251114	5-106114	Estrella	6	3/8"LP	67mm	13mm	26mm	<u>Poulan 2150/2050/2375/260</u>
								
<input type="checkbox"/> 3217168	530 04 70-61	Estrella	6	3/8"LP	74mm	15mm	28,2mm	Poulan 4018/4218
								
<input type="checkbox"/> 3218171	530 05 79-05	Estrella	6	3/8"LP	63,5mm	13mm	23mm	Alpina/Poulan 295
								
<input type="checkbox"/> 3217161	530 04 70-61	Estrella	6	3/8"LP	67mm	13mm	26mm	Poulan 230/260/2150/2175/2250
								
<input type="checkbox"/> 3217271	530 04 80-62	Estrella	7	3/8"LP	76mm	16mm	28,2mm	Poulan 3400/3700/3800/4000
								
<input type="checkbox"/> 3218161	62-65-397	Estrella	6	3/8"LP	57,2mm	13mm	25,2mm	Alpina 338/380
								
<input type="checkbox"/> 3217371	530 06 93-16	Estrella	7	.325"	63,3mm	14mm	28,2mm	Poulan 2500/2600/2750/3050
								
<input type="checkbox"/> 2048118	952 04 81-18	Estrella	7	.325"	63,3mm	14mm	28,2mm	Poulan 2900
								

2 | CORTE Y TRANSMISIÓN

VISITÁ EL BLOG DE GRUPO RUMBO
y encontrará tips y recomendaciones



www.rumbosrl.com.ar/blog



66

PIÑONES

SHINDAIWA / PARTNER / NIWA

PIÑONES PARA MOTOSIERRAS - SHINDAIWA / PARTNER

Cod. Rumbo	Cod. Original	Tipo	Dientes	Paso	Diámetro	Centro	Alto total Tambor / Piñón	Aplicación
<input type="checkbox"/> 3219261	556001010	Estrella	6	3/8"LP	68mm	13mm	27,8mm	<u>Shindaiwa</u> 357/377/3005/360/300/394
<input type="checkbox"/> 3218163	120027	Estrella	6	3/8"LP	58,7mm	13mm	26mm	Partner 330/350 Jons.2035 Husq.36
<input type="checkbox"/> 3219372	2294561100	Estrella	7	.325"	68mm	13mm	31mm	Shindaiwa 305/340/350

PIÑONES PARA MOTOSIERRAS - NIWA

Cod. Rumbo	Cod. Original	Tipo	Dientes	Paso	Diámetro	Centro	Alto total Tambor / Piñón	Aplicación
<input type="checkbox"/> 2137108	Niwa Original	Estrella	7 Dientes	.325"	67mm	14mm	27mm	<u>CNW45/CNW50</u>
<input type="checkbox"/> 2138049	Niwa Original	Estrella	7 Dientes	3/8"	80mm	14mm	26mm	CNW62
<input type="checkbox"/> 2145138	Niwa Original	CTA	7 Dientes	.325"	67mm	14mm	27mm	CNW45/CNW50
<input type="checkbox"/> 2162092	Niwa Original	CTA	7 Dientes	3/8"	80mm	14mm	26mm	CNW62

ANILLOS

SHINDAIAWA / PARTNER / NIWA

67

ANILLOS - HUSQVARNA

Cod. Rumbo	Cod. Original	Dientes	Paso	Modelo	Diámetro interior	Diámetro exterior	Aplicación
 4523002	504 52 30-02	7	3/8"	Standart	22,5mm	35mm	<u>Husqvarna 55</u>
 1598002	501 59 80-02	7	3/8"	Standart	22,5mm	35mm	61/365/372XP/288XP 501 59 80-02
 1597902	501 59 79-02	7	.404"	Standart	22,5 mm	38,7mm	Husqvarna 395XP/394/288

ANILLOS - CARLTON



Cod. Rumbo	Cod. Original	Dientes	Paso	Modelo	Diámetro interior	Diámetro exterior	Aplicación
 3222272	SR7-18720	7	.325	small	19,6mm	32mm	<u>HUSQVARNA 262, 340, 345, 350, 357, 555, ECHO CS-3700ES, CS-4200ES, CHAMPION 250, 55, POULAN 295, 2500, 2600, 2750, 2775,</u>
 3222471	SR7-22270	8	.325	Small	19,3mm	36,2mm	Stihl 017,170
 3222271	SR7-68210	7	3/8"	Standart	22,5 mm	35mm	Husqvarna 61/365/372XP/288XP /55
 3222382	SR8-11891	8	3/8"	Standart	22.5mm	45mm	STIHL 044 046 064 066 MS660 088 MS880 090
 3222281	SR8-22273	7	3/8"	Small	19mm	35mm	Stihl 034, 036, 029, 039, MS290, MS310, MS340, MS360, MS362, MS390, MS391
 3222372	SR7-11892	7	.404	standart	22,5 mm	38,7 mm	Husqvarna 395XP/394/288

68

ANILLOS

ALTERNATIVOS / NIWA

ANILLOS - ALTERNATIVOS

Cod. Rumbo	Cod. Original	Dientes	Paso	Modelo	Diámetro interior	Diámetro exterior	Aplicación
 3220372		7	.325	small	19,6mm	32mm	<u>HUSQVARNA 262, 340, 345, 350, 357, 555, ECHO CS-3700ES, CS-4200ES, CHAMPION 250, 55, POULAN 295, 2500, 2600, 2750, 2775, 2900</u>
 3220382	SRK28	8d	.325	Small	19,3mm	36,2mm	Sthil 017,170
 3220272	QR3757X7	7	3/8"	Small	19mm	35mm	Stihl 034, 036, 029, 039, MS290, MS310, MS340, MS360, MS362, MS390, MS391
 3220271	QR3757B7	7	3/8"	Standart	22,5mm	35mm	Husqvarna 61/365/372XP/288XP /55
 3220281	QR3758B7	8	3/8"	Standart	22,5mm	45mm	STIHL 044 046 064 066 MS660 088 MS880 090
 3220481	SRB18	8	.404	Standart	22mm	45mm	MC CULLOCH D44, 1.70, 1.71, 1.72, 1.73, 1.74, 1.75, 1.76, 105, 125, 200, 250, 300, 380, 440, 450, 550, 740, 790, 795, S797, CP125.
 3220471	QR4047B7	7d	.404	Standart	22,5 mm	38,7mm	Husqvarna 395XP/394/288

ANILLOS - NIWA

Cod. Rumbo	Cod. Original	Dientes	Paso	Modelo	Diámetro interior	Diámetro exterior	Aplicación
 2145056	Niwa Original	7	.325	Standart	19mm	32mm	<u>Niwa CNW45/CNW50</u>
 2162093	Niwa Original	7	.3/8	Standart	20mm	35mm	Niwa CNW62

CAMPANAS
HUSQVARNA

CAMPANAS - HUSQVARNA

Cod. Rumbo	Cod. Original	Encastre Centro	Alto	Diámetro interior	Diámetro exterior	Aplicación
<input type="checkbox"/> 1142001 	581 14 20-01	7 Estrias	53mm	56mm	60mm	Podador de Altura Husqvarna 525PT5S
<input type="checkbox"/> 1609801 	521 60 98-01	7 Estrias	53mm	54mm	57,5mm	Desmalezadora Husqvarna 226R
<input type="checkbox"/> 1425801 	591 42 58-01	9 Estrias	60mm	78mm	82mm	Desmalezadora Husqvarna 143RII / 236R
<input type="checkbox"/> 1659901 	521 65 99-01	10 Estrias	58mm	78mm	82mm	Desmalezadora Husqvarna 553RS
<input type="checkbox"/> 1002251 	531 00 22-51	m 7mm	33mm	77mm	82mm	Desmalezadora Husqvarna 142R/143R
<input type="checkbox"/> 4900701 	544 90 07-01	m 8mm	36mm	69mm	73mm	Desmalezadora Husqvarna 343R/345RX/345FR/545FR
<input type="checkbox"/> 4125001 	574 12 50-01	m 9mm	32mm	54mm	58mm	podador de altura Husqvarna 325s25
<input type="checkbox"/> 7240001 	537 24 00-01	o	39mm	46mm	50mm	Cortacercos de altura Husqvarna 327HE4x
<input type="checkbox"/> 7352901 	537 35 29-01	o	43mm	63,5mm	66mm	Desmalezadora Husqvarna 241R
<input type="checkbox"/> 7237501 	537 23 75-01	o	43mm	64mm	68mm	podador de altura Husqvarna 327PT5S
<input type="checkbox"/> 0150039 	530 15 00-39	o	65mm	63mm	67mm	Desmalezadora Husqvarna 125C/L/R / 128r

70

CAMPANAS

HUSQVARNA / NIWA

CAMPANAS - HUSQVARNA

Cod. Rumbo	Cod. Original	Encastre Centro	Alto	Diámetro interior	Diámetro exterior	Aplicación
<input type="checkbox"/> 6203801	576 20 38-01	o	66mm	78mm	83mm	Desmalezadora Husqvarna 543RB/443RB



CAMPANAS - NIWA

Cod. Rumbo	Cod. Original	Encastre Centro	Alto	Diámetro interior	Diámetro exterior	Aplicación
<input type="checkbox"/> 2260110	Niwa Original	9 Estrias	69mm	54mm	58mm	<u>Desmalezadora Niwa DNW26/podador de altura niwa JNW27</u>
<input type="checkbox"/> 2520332	Niwa Original	9 Estrias	69mm	78mm	82mm	Desmalezadora NiwaDNW33/52
<input type="checkbox"/> 2232111	Niwa Original	o 8mm	38mm	54mm	58mm	Cortacerco Niwa HNW23 m/v
<input type="checkbox"/> 2232430	Niwa Original	o 9mm	31mm	53mm	59mm	Cortacerco Niwa HNW-23 M.Nuevo
<input type="checkbox"/> 2260611	Niwa Original	□	71mm	54mm	56mm	Bordeadora Niwa BNW26
<input type="checkbox"/> 2132163	Niwa Original	□	67mm	62mm	66mm	Bordeadora Niwa BNW-25



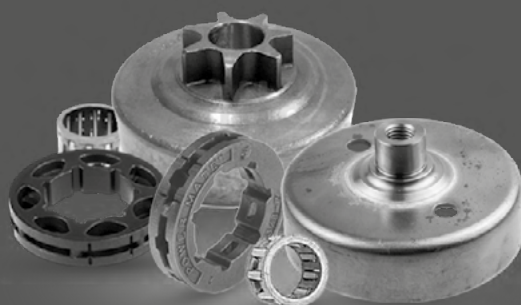

SOPORTE DE CAMPANAS

NIWA / HUSQVARNA

71

SOPORTE DE CAMPANAS

Cod. Rumbo	Cod. Original	Aplicación
<input type="checkbox"/> 2520142 	Niwa Original	Niwa DNW33/52
<input type="checkbox"/> 2260600 	Niwa Original	Niwa BNW26
<input type="checkbox"/> 2260601 	Niwa Original	Niwa DNW26/ JNW27
<input type="checkbox"/> 5292901 	505 29 29-01	Husqvarna 143RII / 236R
<input type="checkbox"/> 1771201 	521 77 12-01	Husqvarna 226R
<input type="checkbox"/> 1664801 	521 66 48-01	Husqvarna 553RS
<input type="checkbox"/> 3701601 	593 70 16-01	Husqvarna 131R

2 | CORTE Y TRANSMISIÓN



Seguinos en **Facebook**

www.facebook.com/gruporumboargentina

www.facebook.com/husqvarnaargentina

www.instagram.com/gardena_ar

www.facebook.com/niwaargentina

www.instagram.com/metabo.ar



Seguinos en **Instagram**

www.instagram.com/gruporumbo.ar

www.instagram.com/husqvarna.ar

www.instagram.com/niwa.ar

72

TAPA DE FRENO

NIWA

TAPA DE FRENO - NIWA

Cod. Rumbo	Cod. Original	Aplicación
<input type="checkbox"/> 2137001	Niwa Original	Motosierra CNW36
<input type="checkbox"/> 2138137	Niwa Original	Motosierra CNW38
<input type="checkbox"/> 2150101	Niwa Original	Motosierra CNW50
<input type="checkbox"/> 2145182	Niwa Original	Motosierra CNW45
<input type="checkbox"/> 2162167	Niwa Original	Motosierra CNW62
<input type="checkbox"/> 2145183	Niwa Original	Motosierra CNW45

G·R·U·P·O
RUMBO



Pedidos



Envío/Retiro



¿Ya conocés nuestra área de autogestión para distribuidores?

Encargá tus repuestos y accesorios en sólo **3 pasos**:

- 1 Te **registras**
- 2 **Buscás** tus repuestos
- 3 **Seleccionás** el tipo de **retiro o envío**.

Para más información contactanos en:

www.rumbosrl.com.ar

TAPA DE FRENO

HUSQVARNA

73

TAPA DE FRENO - HUSQVARNA



Cod. Rumbo	Cod. Original	Aplicación
<input type="checkbox"/> 0053173	530 05 31-73	Motosierra 136
		
<input type="checkbox"/> 3746702	503 74 67-02	Motosierra 288/281XP
		
<input type="checkbox"/> 3106302	503 10 63-02	Motosierra 40/45
		
<input type="checkbox"/> 3498103	503 49 81-03	Motosierra 51/55
		
<input type="checkbox"/> 3736601	503 73 66-01	Motosierra 61/268/272XP
		
<input type="checkbox"/> 7349201	587 34 92-01	Motosierra T435
		
<input type="checkbox"/> 7107801	537 10 78-01	Motosierra 340/345
		
<input type="checkbox"/> 7033501	537 03 35-01	Motosierra 365/372XP
		
<input type="checkbox"/> 5611401	525 61 14-01	Motosierra 235e/240e/236e
		
<input type="checkbox"/> 2102602	582 10 26-02	Motosierra 120/125
		
<input type="checkbox"/> 3731506	503 73 15-06	Motosierra 394XP/395XP
		

74







MANIJAS DE FRENO Y PROTECTORES DE MANO

NIWA / HUSQVARNA

MANIJAS DE FRENO

Cod. Rumbo	Cod. Original	Aplicación
<input type="checkbox"/> 2138139	Niwa Original	Niwa CNW38
		
<input type="checkbox"/> 2162156	Niwa Original	Niwa CNW62
		

PROTECTORES DE MANO

Cod. Rumbo	Cod. Original	Aplicación
<input type="checkbox"/> 5636901	575 63 69-01	Motosierra Husqvarna 236e
		
<input type="checkbox"/> 7611901	577 61 19-01	Motosierra Husqvarna 236e
		
<input type="checkbox"/> 3764903	503 76 49-03	Motosierra Husqvarna 365/372XP
		
<input type="checkbox"/> 4251501	544 25 15-01	Motosierra Husqvarna 435e
		
<input type="checkbox"/> 4082601	544 08 26-01	Motosierra Husqvarna 445e
		
<input type="checkbox"/> 7284301	537 28 43-01	Motosierra Husqvarna 455e
		
<input type="checkbox"/> 3727401	503 72 74-01	Motosierra Husqvarna 61 / 2 / 272XP
		
<input type="checkbox"/> 3892701	503 89 27-01	Motosierra Husqvarna 55
